

Side view

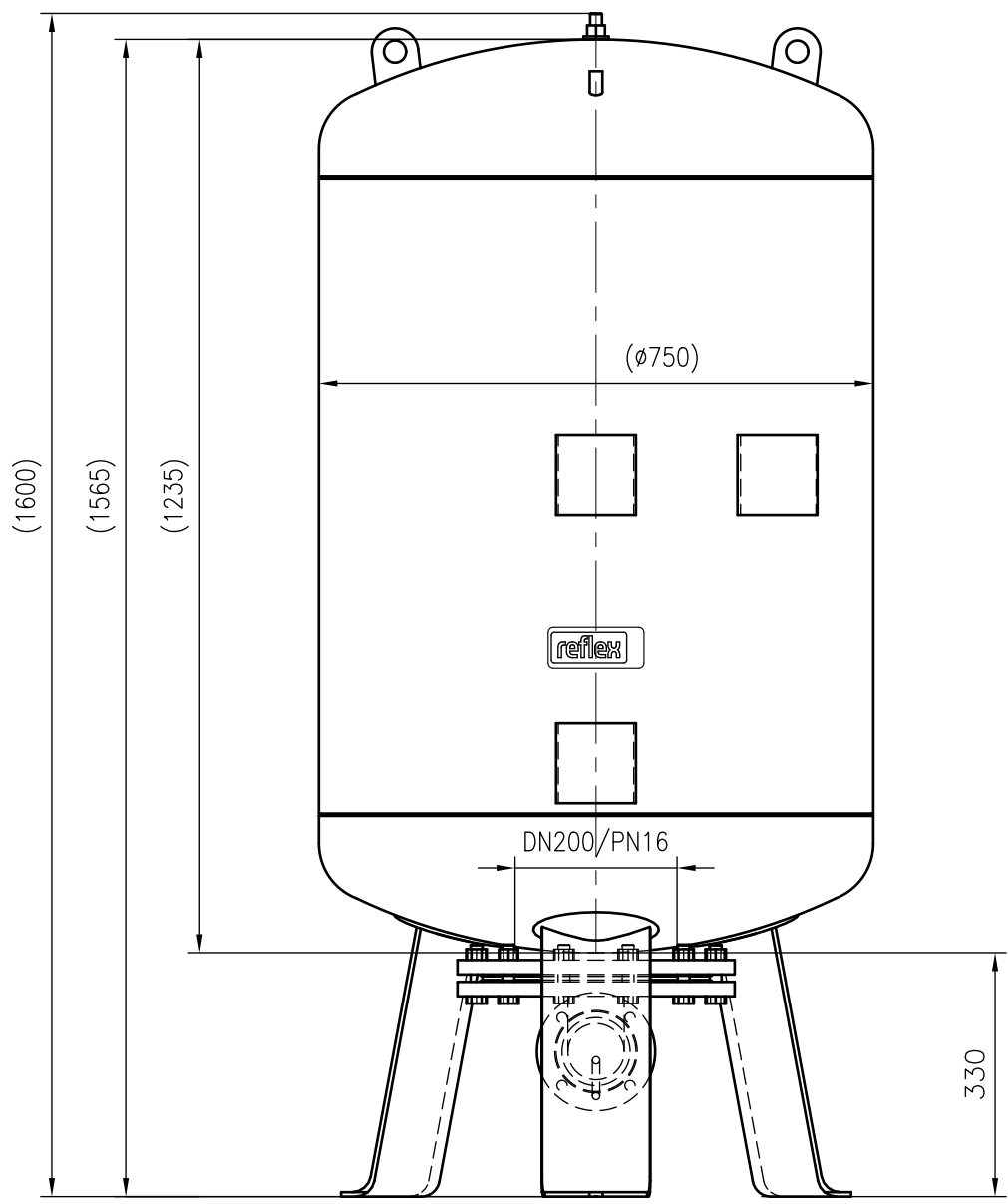

Front view

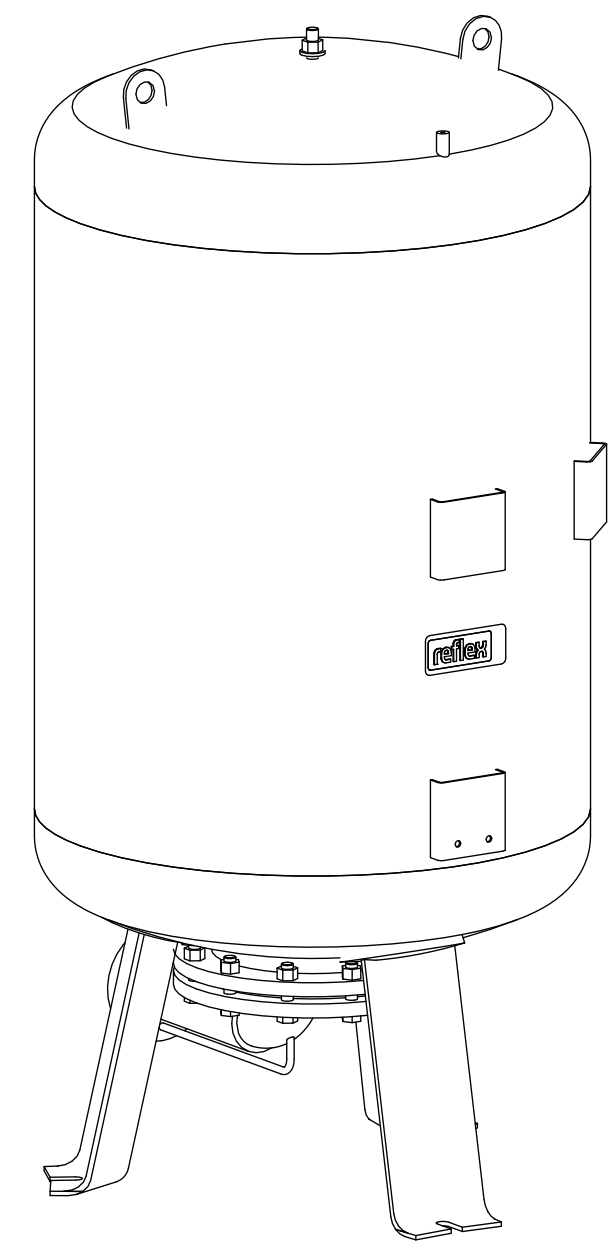

Isometric view

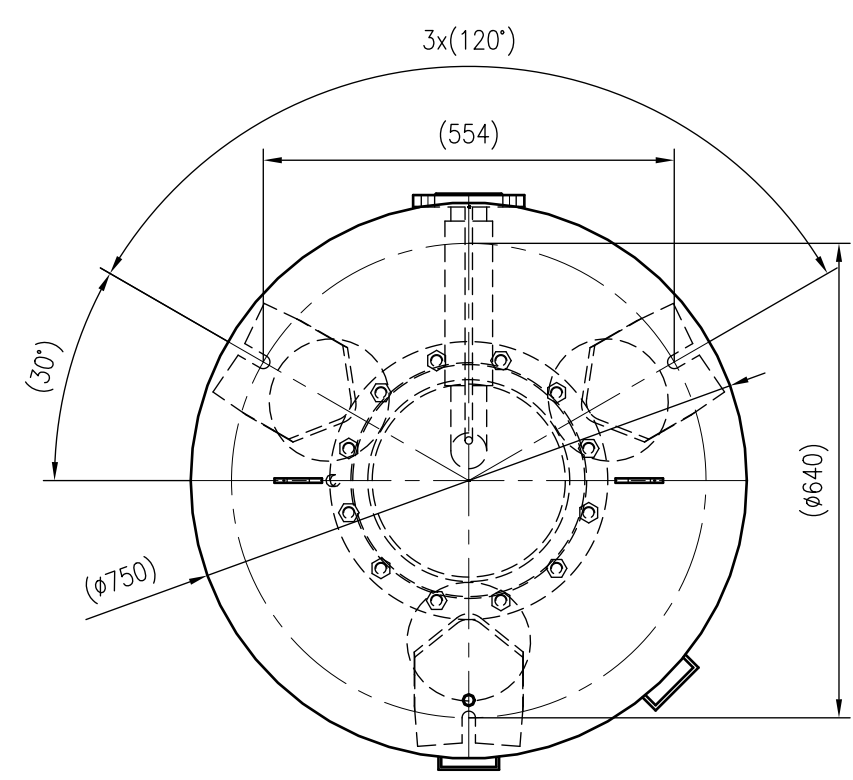

Top view



Unterliegt nicht dem Änderungsdienst/ Not subject to change management	Maßstab/ Scale: 1:10	Format/ Size: A2
Revision 24.03.2016	Reflexomat RF500 10bar – 8654400	